

PROFILES

SCALE: NTS

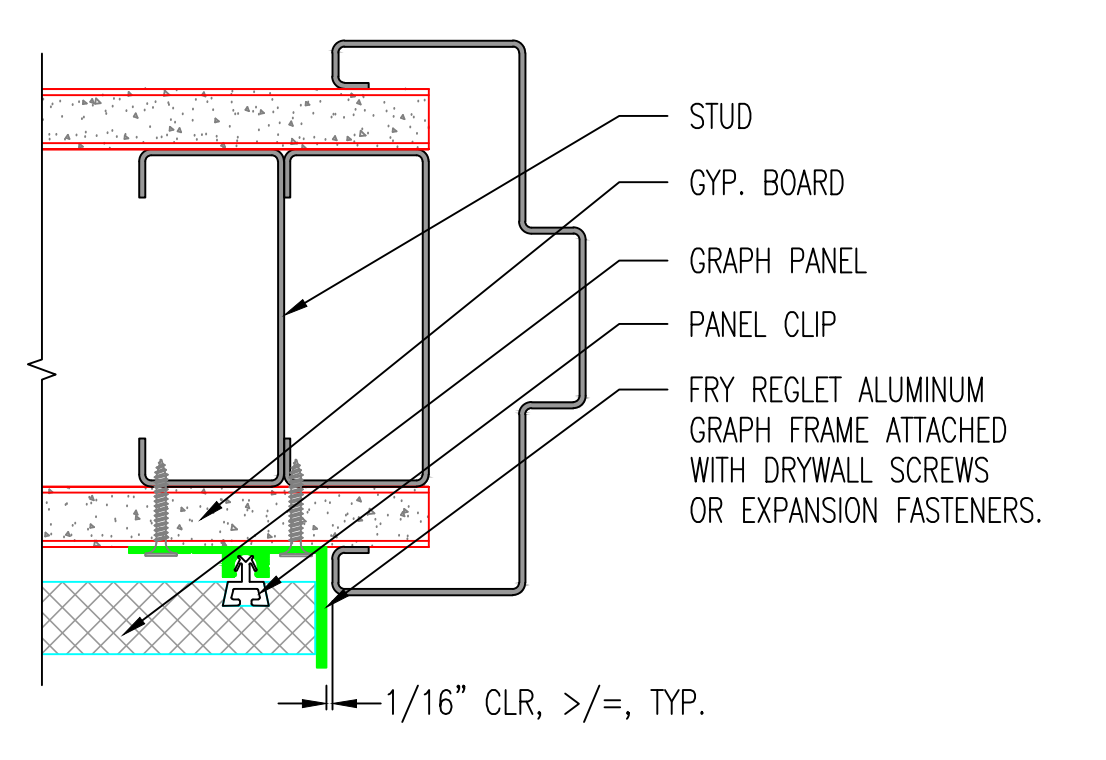
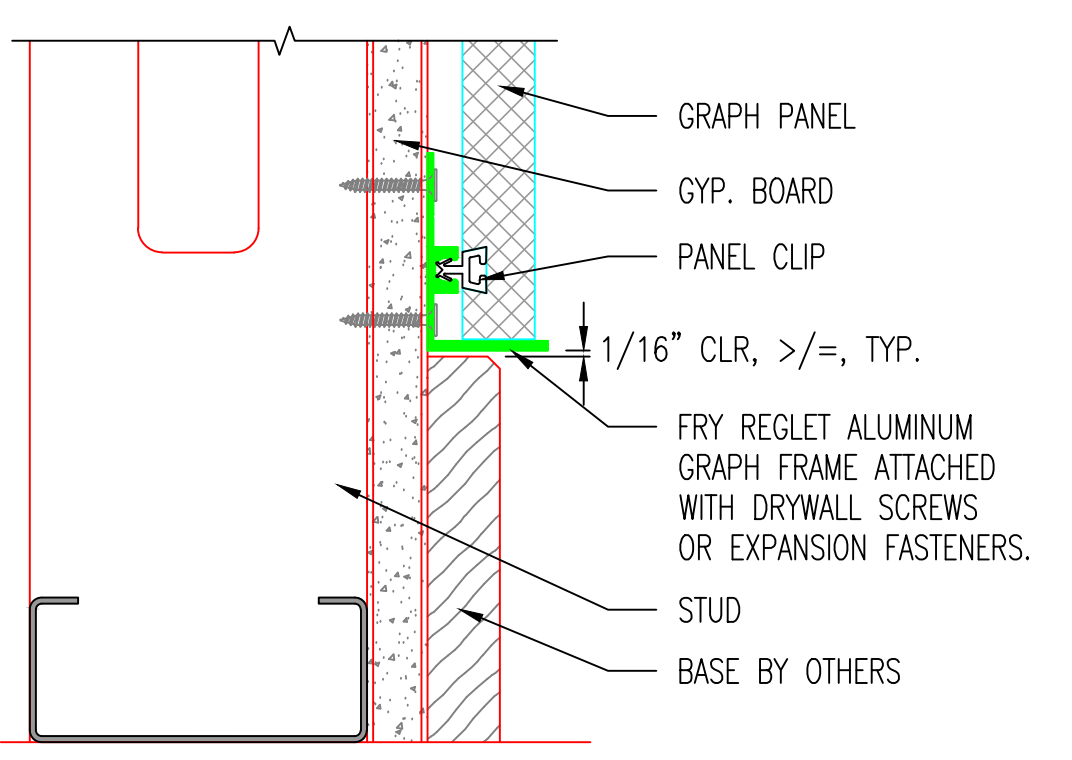
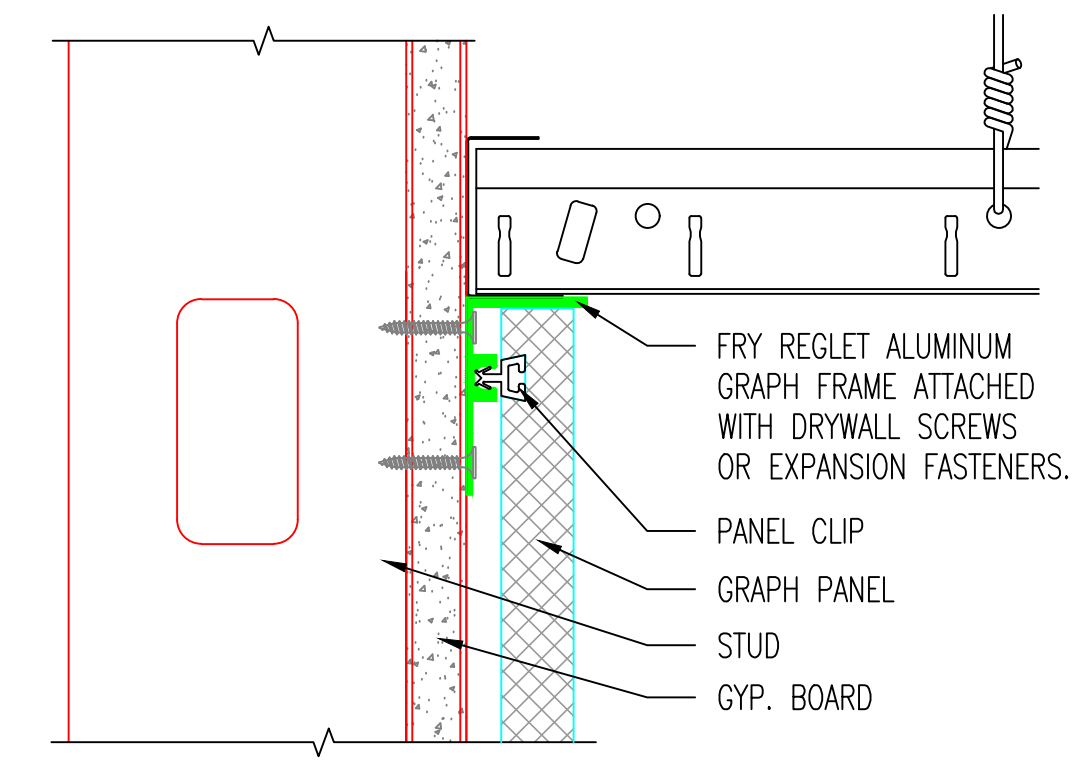
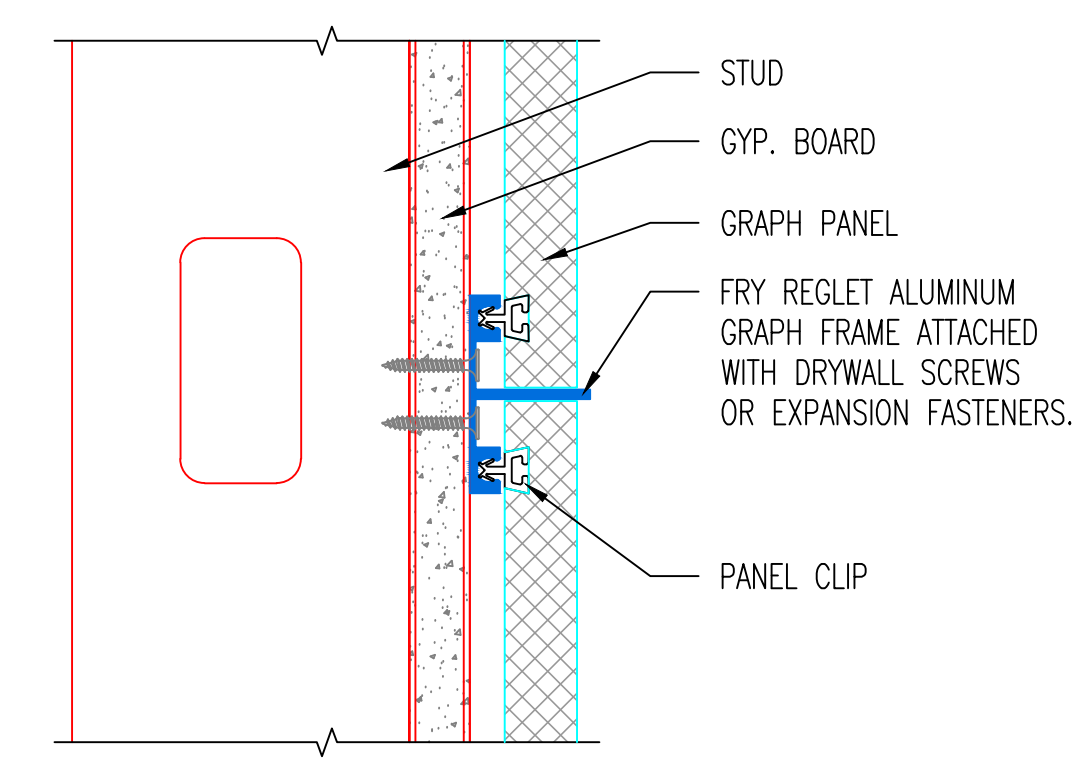
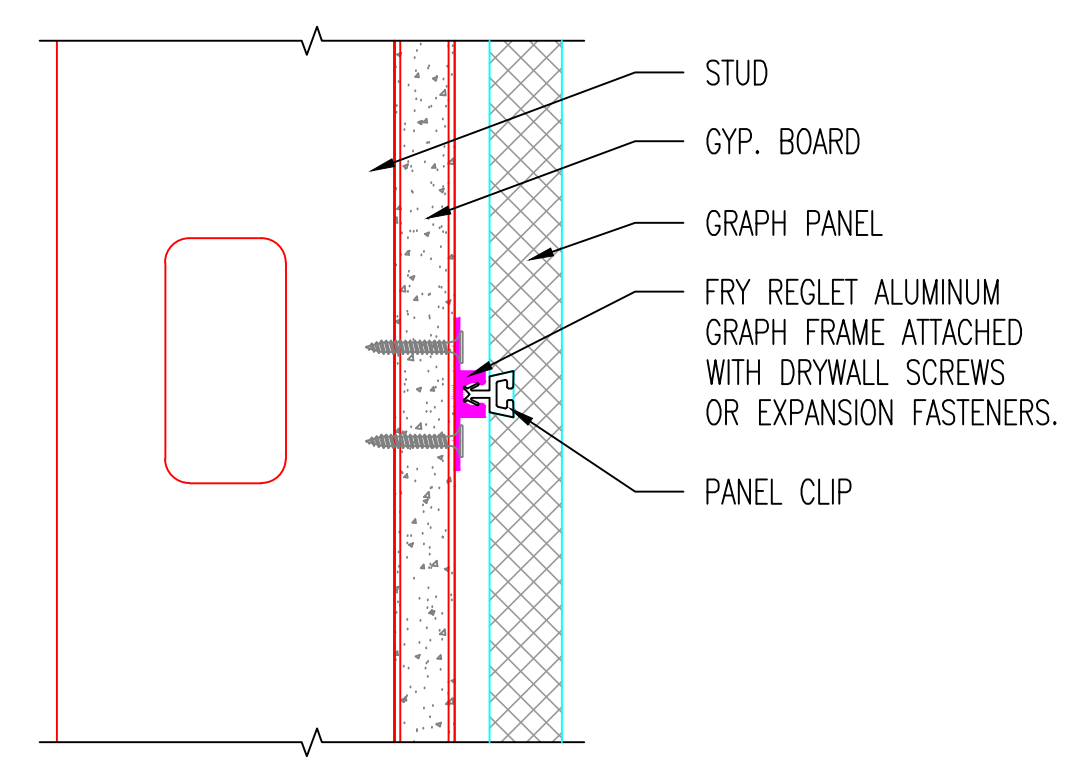

A INTERMEDIATE RETAINER DETAIL-3/4" PANEL SCALE: NTS

B PANEL RETAINER DETAIL-3/4" PANEL SCALE: NTS

C CEILING TERMINATION DETAIL-3/4" PANEL SCALE: NTS

D TERMINATION AT BASE DETAIL-3/4" PANEL SCALE: NTS

E JAMB DETAIL-3/4" PANEL SCALE: NTS

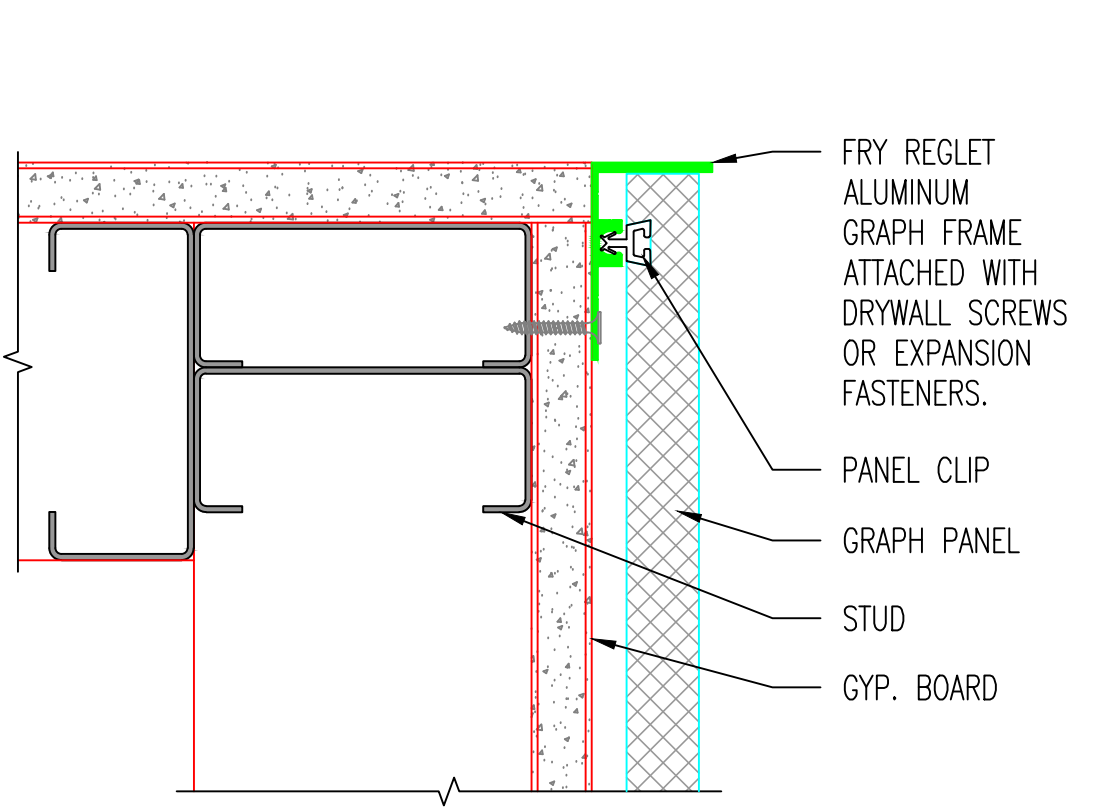
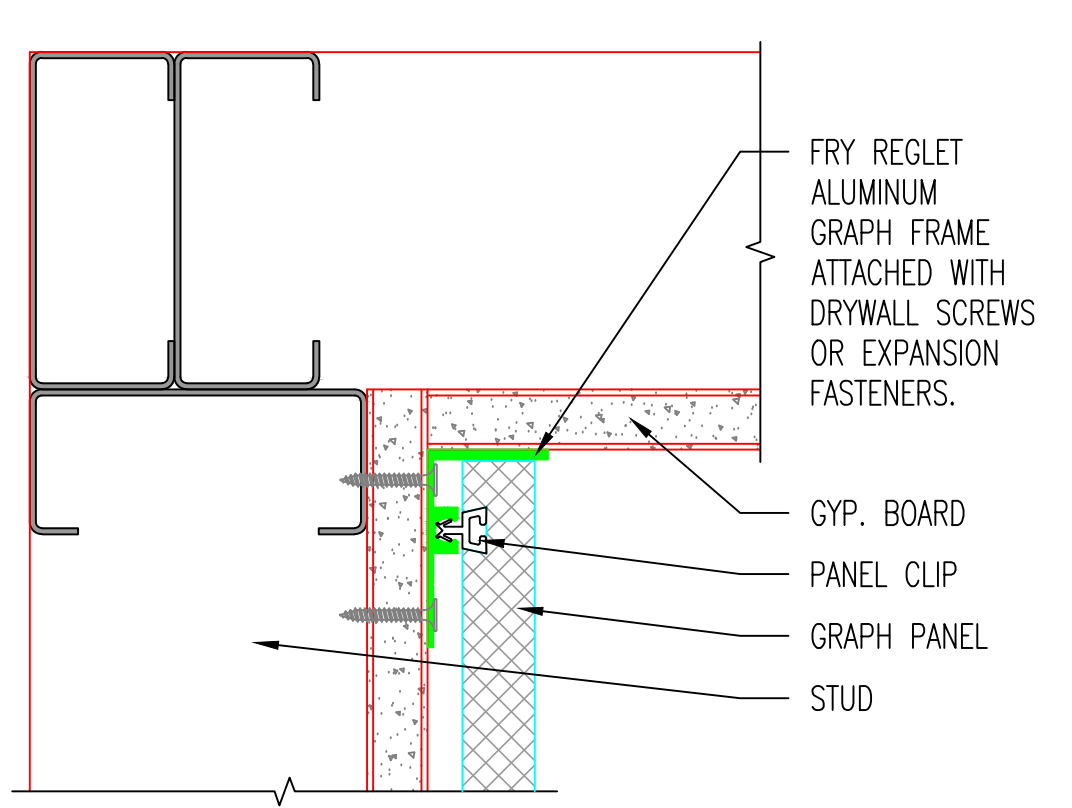
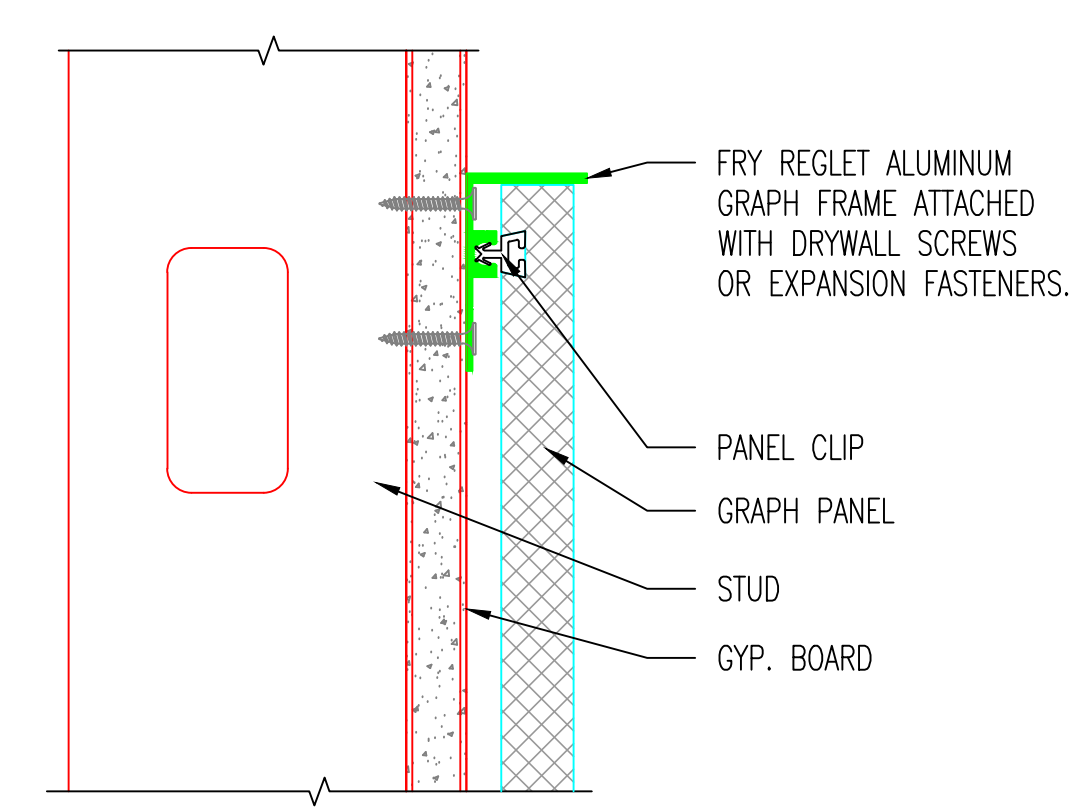
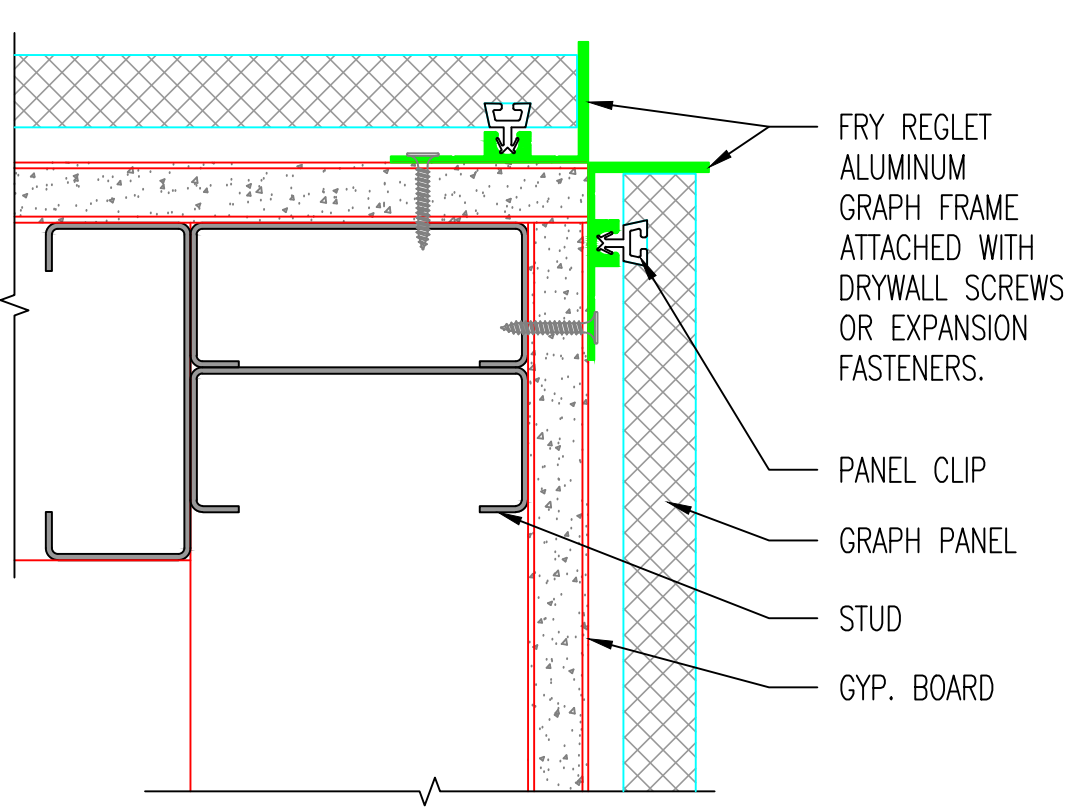
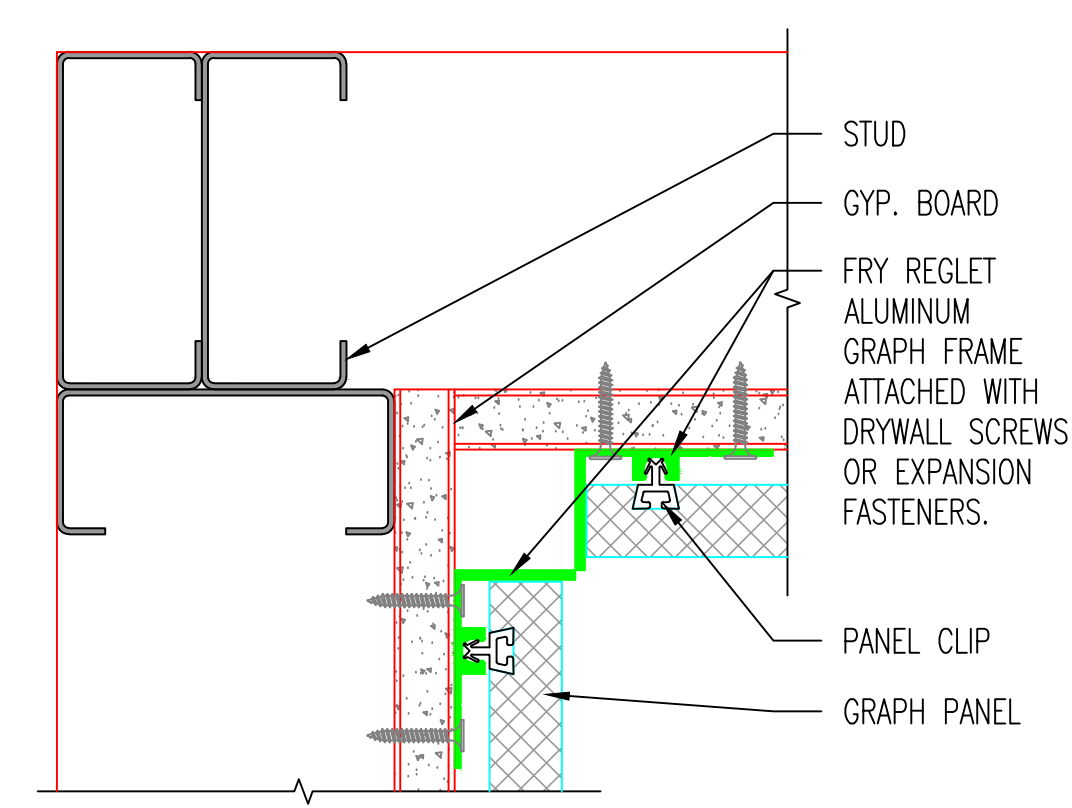

F INSIDE CORNER DETAIL-3/4" PANEL SCALE: NTS

G OUTSIDE CORNER DETAIL-3/4" PANEL SCALE: NTS

H TERMINATION DETAIL-3/4" PANEL SCALE: NTS

J INSIDE CORNER TERMINATION DETAIL-3/4" PANEL SCALE: NTS

K CORNER TERMINATION DETAIL-3/4" PANEL SCALE: NTS

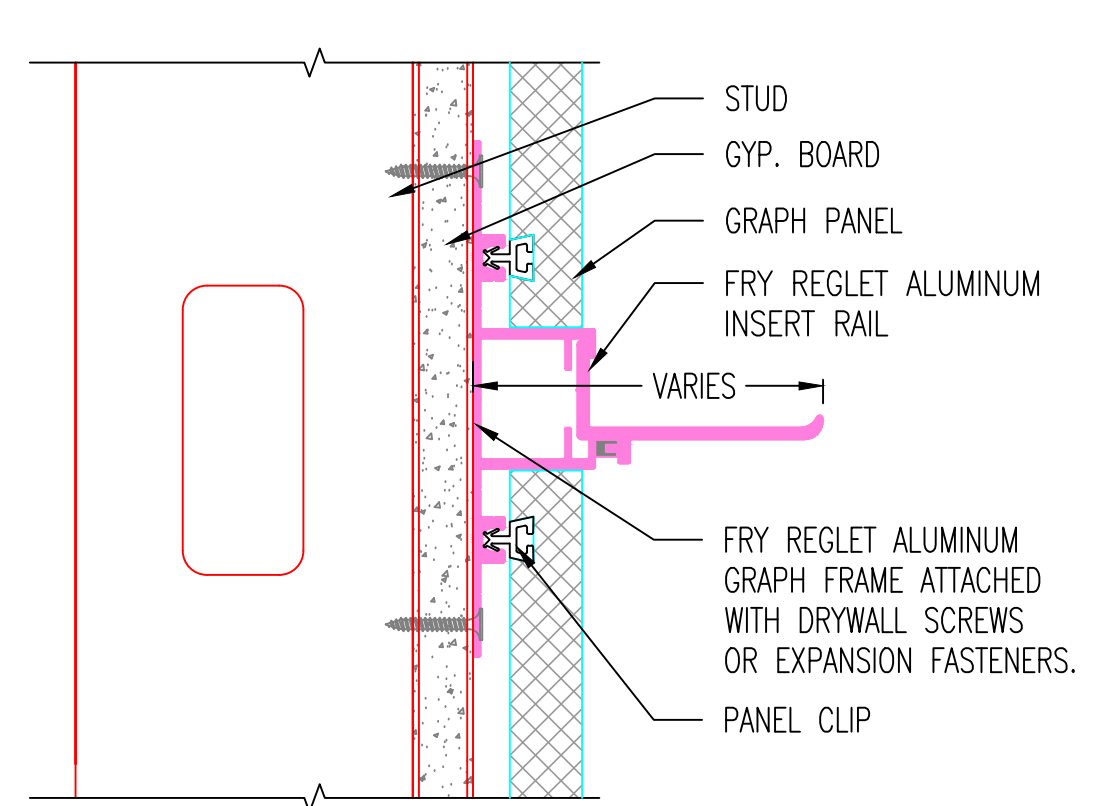
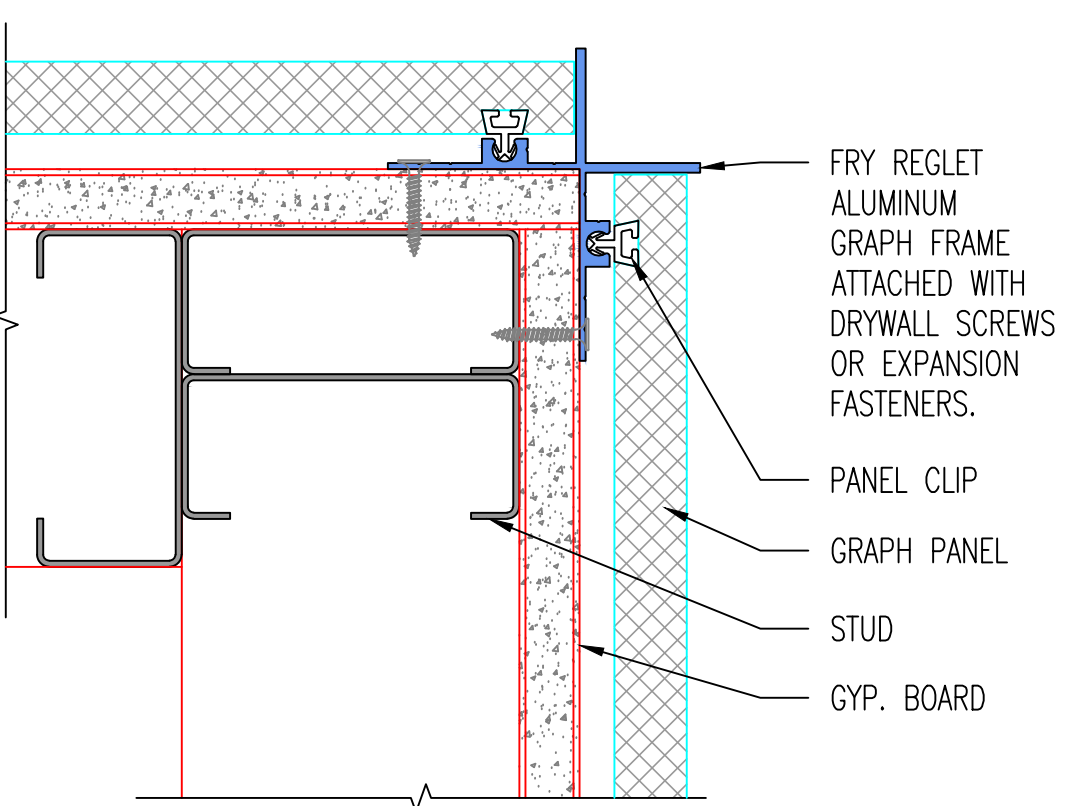
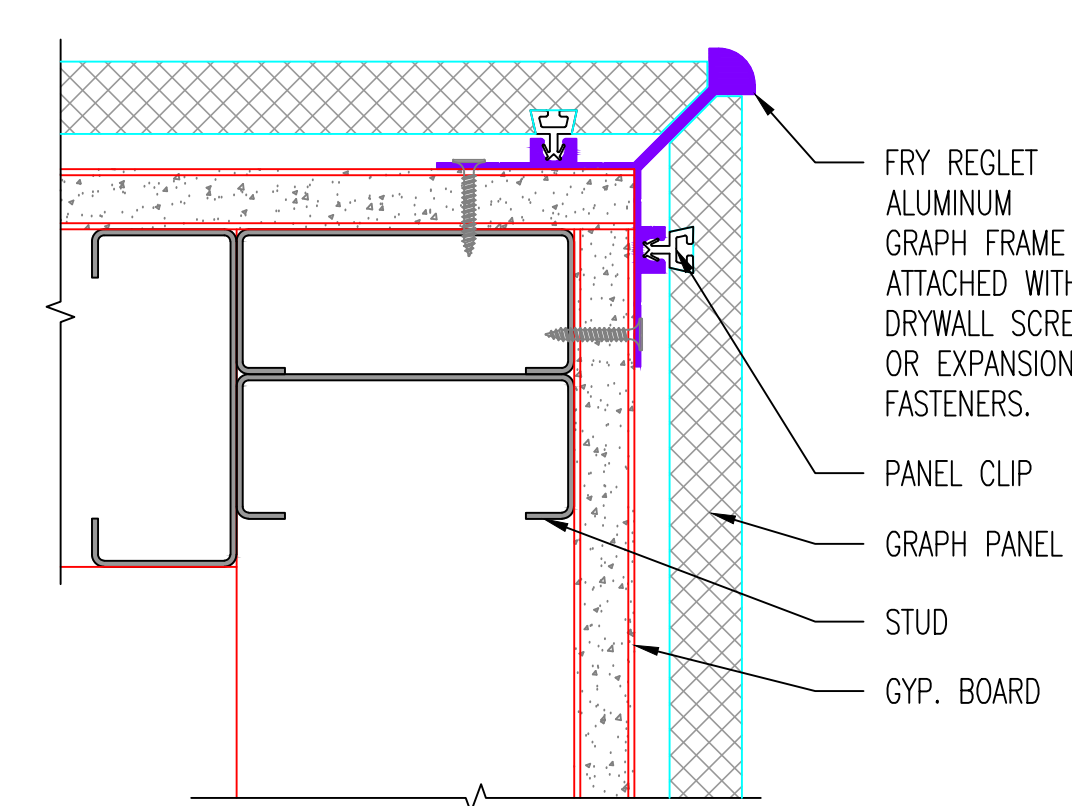
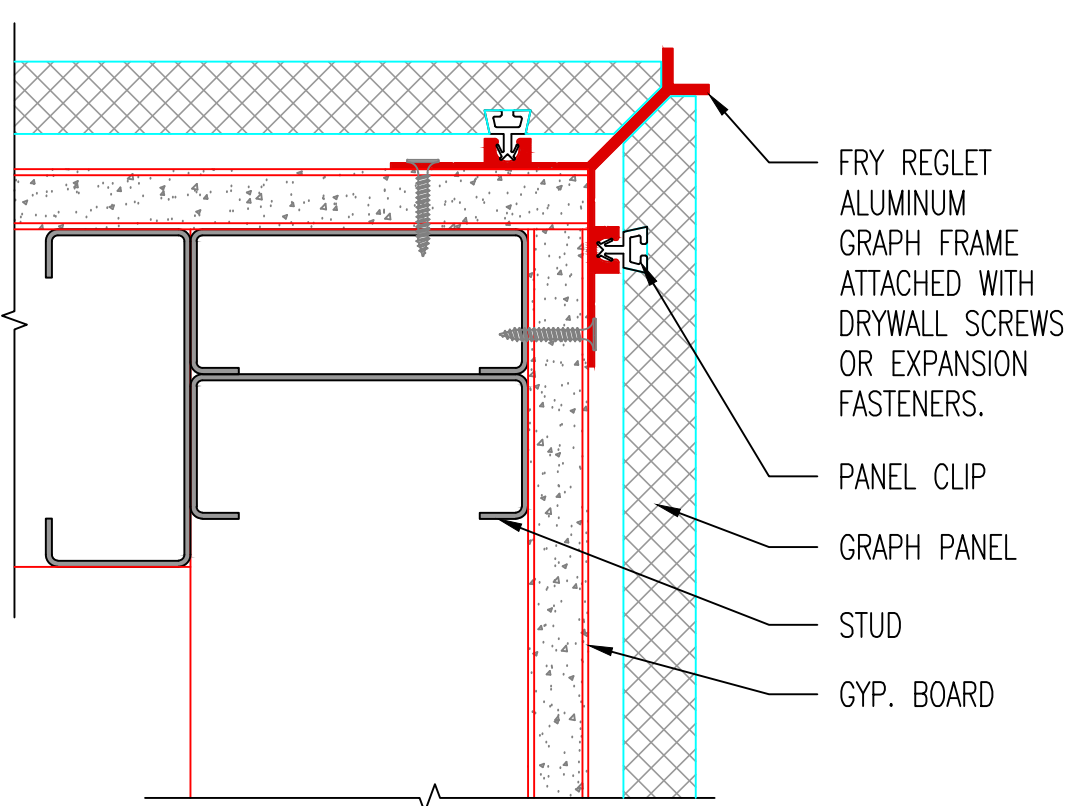
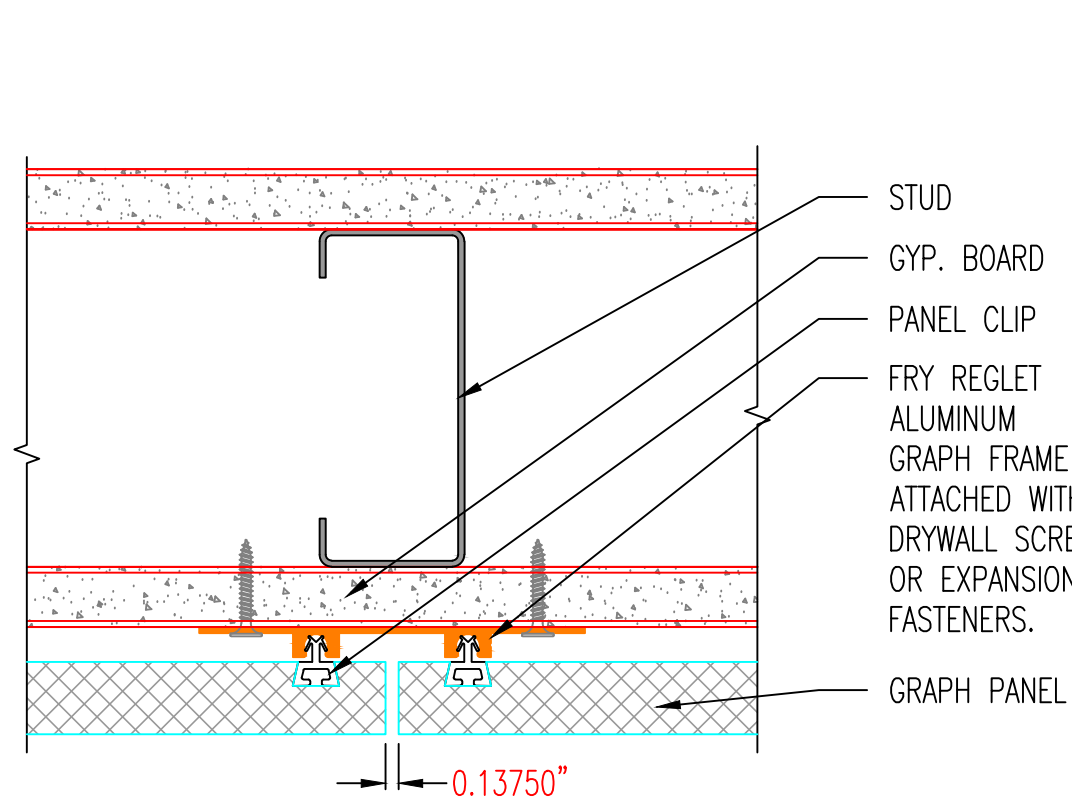

L BUTT REVEAL DETAIL-3/4" PANEL SCALE: NTS

M OPEN CORNER DETAIL-3/4" PANEL SCALE: NTS

N BULLNOSE CORNER DETAIL-3/4" PANEL SCALE: NTS

O X CORNER DETAIL-3/4" PANEL SCALE: NTS

P INTEGRATED FUNCTIONAL REVEAL (IFR) DETAIL SCALE: NTS

STANDARD DETAILS
1-1/4" SINGLE FIN GRAPH FRAME
3/4" ROUTED PANEL

ALPHARETTA, GA
SANTA FE SPRINGS, CA
WWW.FRYREGLET.COM

FRY REGLET
ARCHITECTURAL METALS

graph

Rev.	Date	Comments

JOB NO#	STANDARD DETAILS
SHOPS BY	WRD
CHK'D BY	-
MFG. BY	-
CHK'D BY	-
SCALE	NTS
DATE	05/06/16
SHEET NUMBER	DR100

6/10/2016 8:16:44 AM, wduley